

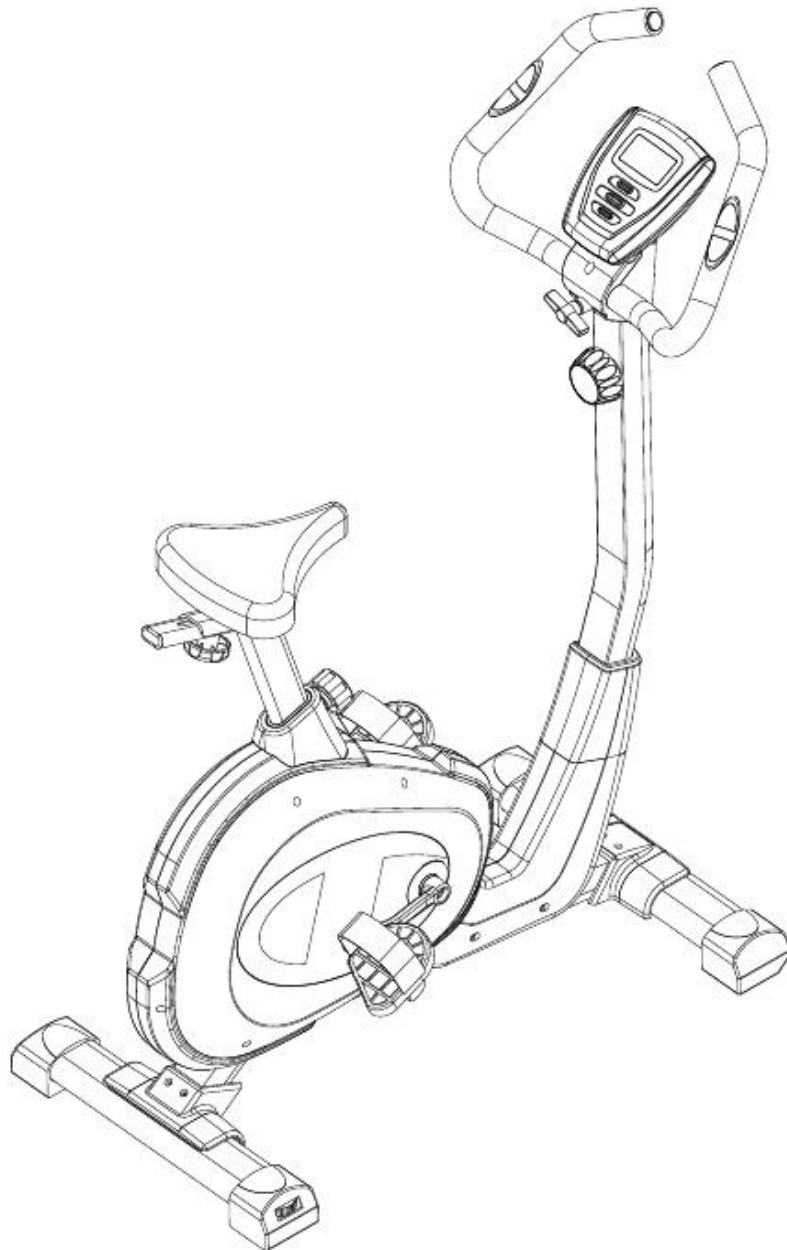

USER MANUAL – EN

IN 11188 Magnetic Bike inSPORTline Klegan



CONTENTS

- IMPORTANT SAFETY NOTICE 3
- CHECK LIST (CONTACT PACKAGE) 5
- HARDWARE PACKING LIST 6
- EXPLODED VIEW (ASSEMBLY) 7
- EXPLODED VIEW (DETAIL) 8
- PARTS LIST 9
- ASSEMBLY INSTRUCTIONS 11
- COMPUTER INSTRUCTIONS 15
- EXERCISE INSTRUCTIONS 16
- TERMS AND CONDITIONS OF WARRANTY, WARRANTY CLAIMS 18

CAUTION: Exercise of a strenuous nature, as is customarily done on this equipment, should not be undertaken without first consulting a physician. No specific health claims are made or implied as they relate to the equipment. Measurements made by the equipment are believed to be accurate, but only the measurement of your physician should be relied upon.

IMPORTANT: Read all instructions carefully before using this product. Keep this owner's manual for future reference. Product may vary slightly from picture.

CAUTION: Weight on this product should not exceed 110KGS.

IMPORTANT SAFETY NOTICE

Thank you for purchasing our product. Even though we go to great efforts to ensure the quality of each product we produce, occasional errors and /or omissions do occur. In any event should you find this product to have either a defective or a missing part, please, contact us for a replacement.

This product has been designed for home use only. Product liability and guarantee conditions will not be applicable to products being subjected to professional use or products being used in a gym center.

This exercise equipment was designed and built for optimum safety. However, certain precautions apply whenever you operate a piece of exercise equipment. Be sure to read the entire manual before assembly and operation of this machine. Also, please note the following safety precautions:

This exercise machine is built for optimum safety. However, certain precautions apply whenever you operate a piece of exercise equipment. Be sure read the entire manual before you assemble or operate your machine. In particular, note the following safety precautions.

1. Read all instruction in this manual before using this equipment.
2. Use the machine only for its intended use as described in this Manual.
3. Inspect and tighten all the loose parts before this equipment is use.
4. Keeps hands away from moving parts.
5. Keep children and pets away from the machine at all time. DO NOT leave children unattended in the same room with the machine.
6. Before using the machine to exercise, always do stretching exercise to properly warm up.
7. Inspect the machine before each use; make sure all of the connections are tightly secured.
8. Only one person at a time should use the machine.
9. If the user experiences dizziness, nausea, chest pain, or any other abnormal symptoms, STOP the workout at once. CONSULT A PHYSICIAN IMMEDIATELY.
10. Position the machine on a clear, levelled surface. DO NOT use the machine near water or outdoor.
11. Always wear appropriate workout clothing when exercising. DO NOT wear robes or other clothing that could become caught in the machine. Sporting shoes are recommended when using the machine.
12. Do not place any sharp object around the machine.
13. Disabled persons should not use the machine without a qualified person or physician in attendance.
14. Never operate the machine if the machine is not functioning properly.
15. Only carry out training work on the equipment when it is in perfect working order. Only use original spare parts in the event of a repair.
16. Do not use strong solvents for cleaning, and only use the tools supplied, or suitable ones of your own, for any repairs that may be required.
17. Please dispose of the packaging and any parts that have to be replaced subsequently (all parts for the unit) at suitable collecting points or containers with a view to saving the environment.

18. DO NOT pull out the seat tube over the warning line “max” which showing on the tube, when you adjust the height of the seat.
19. Not for therapeutic use.
20. For your own safety, always ensure that there is at least 0.6 meter of free space in all directions around your product while you are exercising.
21. **WARNING! The heart rate monitor may not be accurate. Overloading during training may cause serious injury or death. If you feel any discomfort, immediately stop the exercise!**









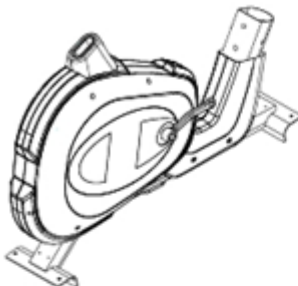

WARNING: Before beginning any exercise program, consult your physician. This is especially important for persons with pre-existing health problems. The seller assumes no responsibility for personal injury or property damage sustained by or through the use of this product.

SERVICE HINTS: The high quality standard of this product only will be kept if you on a regular basis check all screw-connections and moving parts on proper fitting. Damaged parts have to be changed immediately. During the time of repair the product must not be used by anybody.





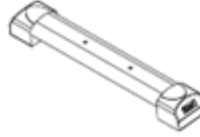
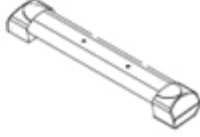



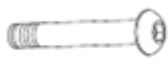

IMPORTANT HINTS:

- A) This product has been tested in accordance with the requirements of **EN 957-1/A1, EN 957-5** standard, Class **HC** (HOME USE). The maximum load is limited to 110KGS.
- B) Parents should be aware of their responsibility with respect to their children natural play instinct. This can cause situations in which the product can be used for other purpose than intended.
- C) If children are allowed to use the product, the mental and physical condition and the temper of the children should be taken in consideration. Make sure that the children are instructed properly in the use of the product and in the controlled execution of the different exercise. Point out especially that the product is not any kind of toy.

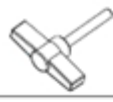
CHECK LIST (CONTACT PACKAGE)

PART NO.	DESCRIPTION	Q'TY	SKETCH	
1/15/17	MAIN FRAME/CHAIN COVER/ CRANK	1 SET		
36/51/35	HANDLEBAR/FOAM GRIP/ HAND PULSE	1 SET		
23/27/64 /24	SEAT TUBE/SLIDE BRACKET/ FLAT WASHER/KNOB	1 SET		
70/32/53	FRONT POST/TENSION CONTROL/BOLT	1 SET		
28/41/46	SEAT/FLAT WASHER/ NYLON NUT	1 SET		
38	FRONT COVER	1		
34/55	COMPUTER/BOLT	1 SET		
6/3	FRONT STABILIZER COVER /REAR STABILIZER COVER	1 SET		
2/4	REAR STABILIZER TUBE /ADJUSTABLE END CAP	1 SET		
5/7	FRONT STABILIZER TUBE /TRANSFORMER END CAP	1 SET		
18R/26L	PEDAL SET	1 SET		
19	RELEASE KNOB	1		

HARDWARE PACKING LIST

PART NO.	DESCRIPTION	Q'TY	SKETCH	
40	BOLT M8X55	4		
41	FLAT WASHER 18/8.5X1.5	4		
50	SCREW M4X15	6		
31/33	CLAMP COVER SET	1 SET		
29	T KNOB	1		
30	BUSHING	1		
48	SCREW M4X20	2		
52	FLAT WASHER 10X5	2		
	TOOL 1	1		
	TOOL 2	1		

EXPLODED VIEW (ASSEMBLY)

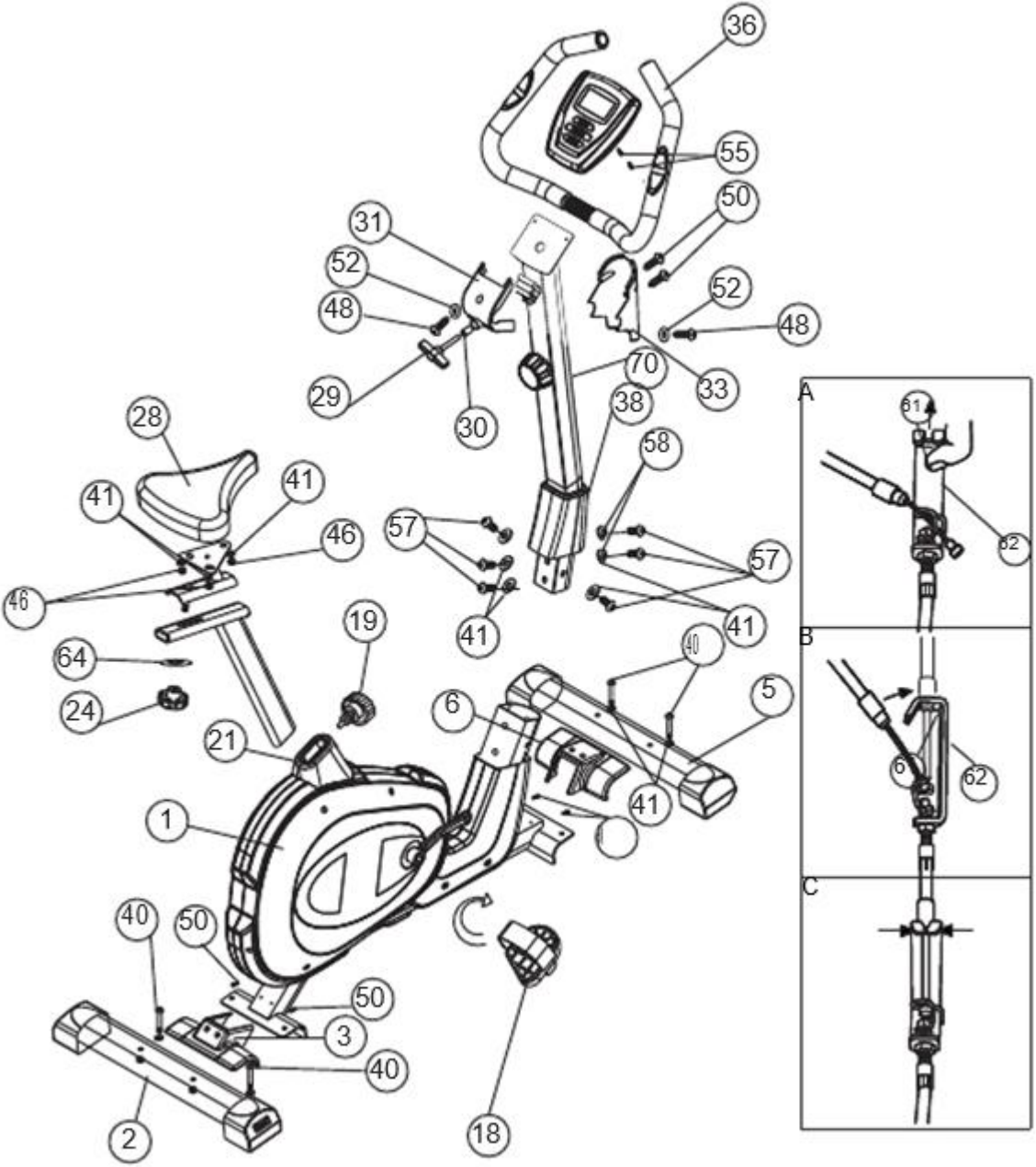

EXPLODED VIEW (DETAIL)

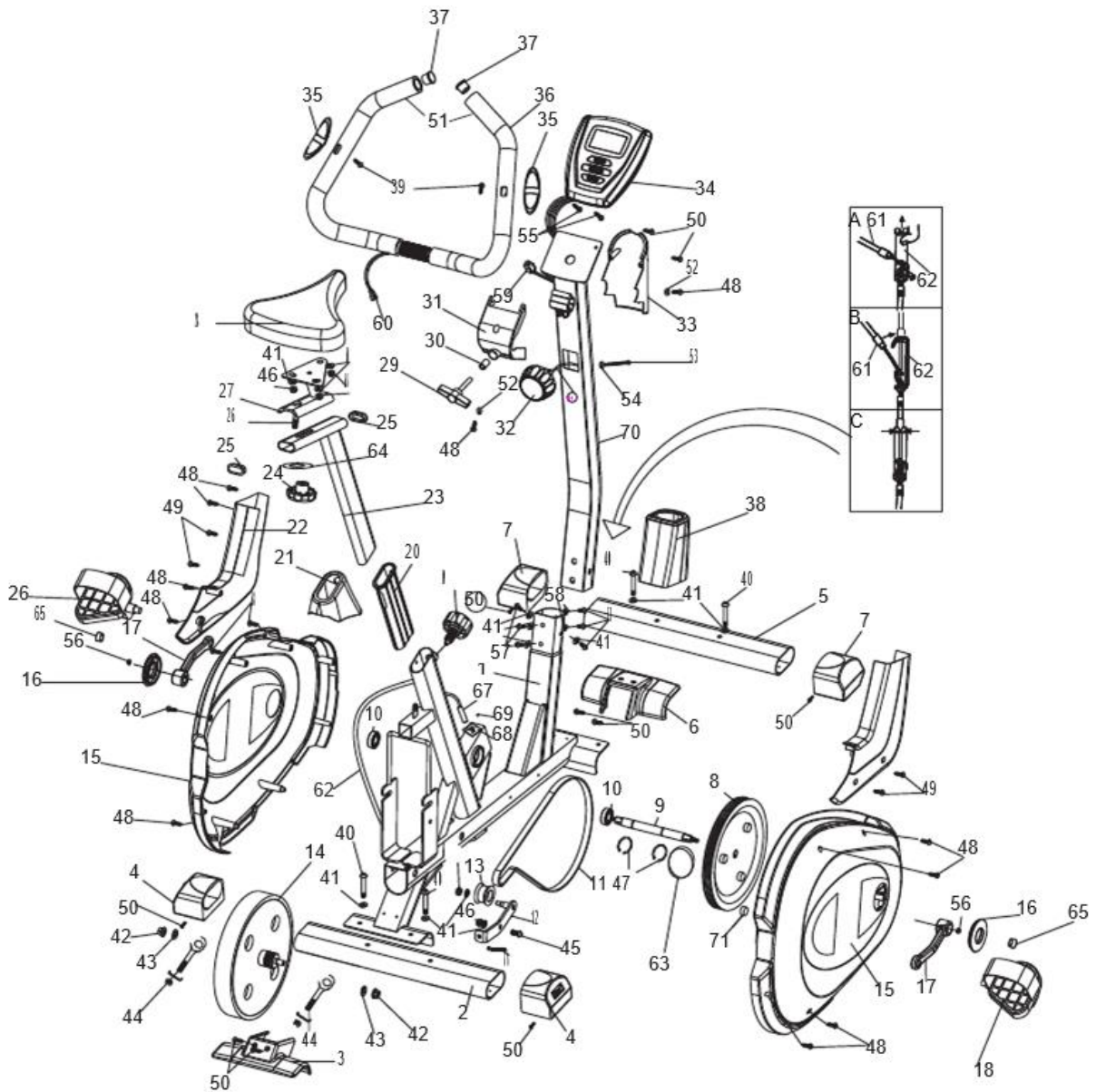

PARTS LIST

NO.	DESCRIPTION	QTY
1	MAIN FRAME	1
2	REAR STABILIZER TUBE	1
3	REAR STABILIZER COVER	1
4	ADJUSTABLE END CAP	2
5	FRONT STABILIZER TUBE	1
6	FRONT STABILIZER COVER	1
7	TRANSFORMER WHEEL END CAP	1set
8	PULLEY	1
9	AXLE	1
10	BELT	2
11	BELT	1
12	IDLE WHEEL BRACKET	1
13	IDLE WHEEL	1
14	FLYWHEEL	1
15	CHAIN COVER (R) & (L)	1set
16	CRANK COVER	2
17	CRANK R & L	1set
18	PEDAL RIGHT	1
19	RELEASE KNOB	1
20	CUP	1
21	REAR COVER	1
22	FRONT CHAIN COVER R& L	1set
23	SEAT TUBE	1
24	KNOB	1
25	END CAP	2
26	PEDAL LEFT	1
27	SLIDE BRACKET	1
28	SEAT	1
29	T KNOB	1
30	BUSHING	1
31	REAR CLAMP COVER	1
32	TENSION CONTROL	1

33	FRONT CLAMP COVER	1
34	COMPUTERE	1
35	HAND PULSE	2
36	HANDLEBAR	1
37	ROUND END CAP	2
38	FRONT COVER	1
39	SCREW FOR HAND PULSE	2
40	BOLT M8X55	4
41	FLAT WASHER 18/8.5X1.5	10
42	STOP NUT	2
43	FLAT WASHER 20/10X2	2
44	ADJUSTABLE BOLT M6x36	2
45	SPECIAL BOLT	1
46	NYLON NUT	2
47	“C” RING	2
48	SCREW M4X20	14
49	SCREW M4X20	4
50	SCREW M4X15	10
51	FOAM GRIPS	2
52	FLAT WASHER 10/5	2
53	BOLT	1
54	WASHER	1
55	BOLT	2
56	STOP NUT	2
57	BOLT M8X15	6
58	CURVED WASHER 20/8.5X1.5	2
59	MIDDLE SENSOR WIRE	1
60	HAND PULSE WIRE	1
61	MIDDLE TENSION CABLE WIRE	1
62	LOWER TENSION CABLE WIRE	1
63	CURVED WASHER	1
64	FLAT WASHER 22/8.5X1.5	1
65	CRANK CAP	2
66	SPRING	1
67	SENSOR	1

68	SENSOR BRACKET	1
69	SCREW	2
70	FRONT POST	1
71	MAGNET	1

ASSEMBLY INSTRUCTIONS

GENERAL: Remove all the part of your cycle from the carton and place them to the floor carefully. Assembling your cycle is simple. Follow these instructions carefully and it should take you around 15-20 minutes.

STEP 1 ATTACH THE STABILIZERS

Attach rear stabilizer (2) with 2 adjustment end caps (4) to the welded cross bar bracket of main frame (1) and fasten with 2 flat washers (41) and 2 bolts (40).

Attach front stabilizer (5) with 2 transportation end cap (7) to the welded cross bar bracket of main frame (1) and fasten with 2 flat washers (41) and 2 bolts (40).

Put the front stabilizer cover (6) to the welded cross bar bracket and fasten with 2 screws (50).

Put the rear stabilizer cover (3) to the welded cross bar bracket and fasten with 2 screws (50).

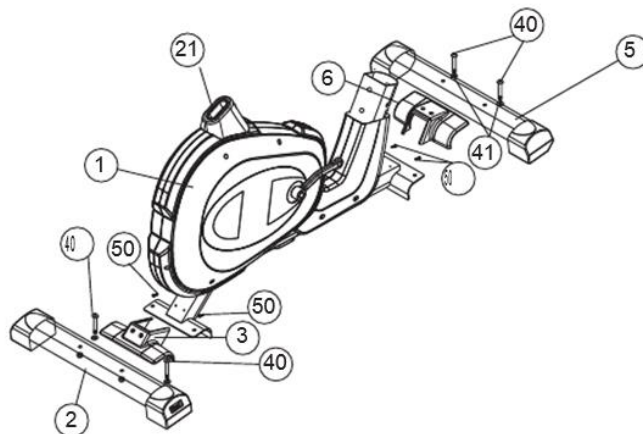

STEP 2 ATTACH THE SEAT AND SEAT POST

Remove the pre-assembled nylon nuts (46) and flat washers (41) from back of the seat (28). Fix the seat (28) with the top seat sliding bracket (27) and fasten with nylon nuts (46) and flat washers (41).

Remove the pre-assembled M10 knob (24) and flat washer (64) from back of the seat sliding bracket (27). Fix the seat sliding bracket (27) with the top bracket of seat tube (23) and fasten with M10 knob (24) and flat washer (64).

Attach seat tube (23) into the main frame (1) and secure in right position with the seat post quick release knob (19). Adjust the height of seat by choosing the hole of seat tube.

NOTE: DO NOT pull out the seat tube over the warning line "MAX" which showing on the tube. When you adjustable the height of seat.

Assemble each pedal (18R&26L) to the crank. Pedal "R" assemble with crank right side, Pedal "L" assemble with crank left side: See the mark "R" & "L" (right and left) on the pedals (18R&26L) and crank.

NOTE: The right pedal "R" should be threaded on clockwise. The left pedal "L" should be threaded on counter-clockwise.

Attach the pedal straps to the pedals (18R&26L).

NOTE: Adjust the pedal straps to meet your foot/shoes size by 4 adjustable holes.

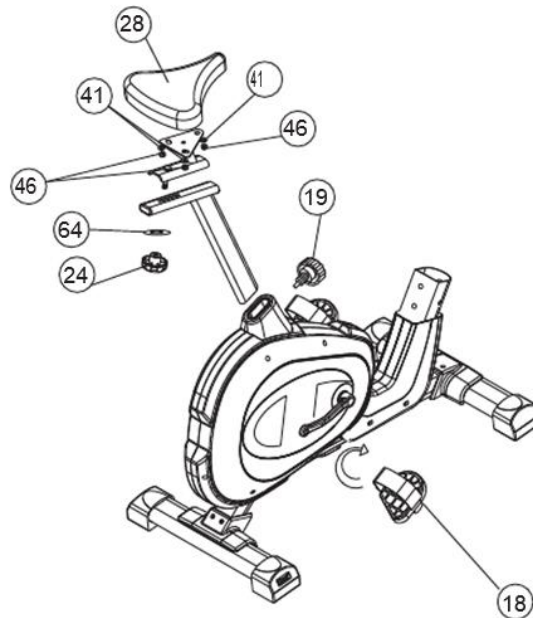

STEP 3 ATTACH THE FRONT POST

Remove the pre-assembled 4 Allen head bolts (57) and 2 curve washers (58) and 2 flat washers (41) from the main frame (1).

Connect the middle section sensor wire (59) of the front post (70) with the lower section sensor wire securely.

Connect the tension cable (61) with lower tension cable (62). (See figure A-B). Put the front post (70) and front cover (38) into the bottom post of main frame (1) and fasten with 4 Allen head bolts (57), 2 curve washers (58) and flat washers (41). Please note don't tighten all head bolts (57) too much at the beginning. When all parts are fixed already, and then fasten each one piece tightly.

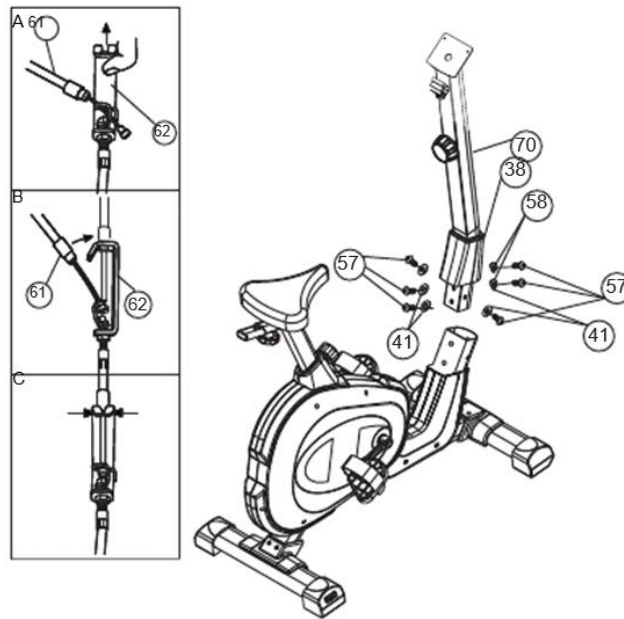

STEP 4 ATTACH HANDLEBAR AND METER

Put handlebar (36) with 2 hand pulse (35), foam grip (51) to the top welded shape handlebar bracket of the front post (70) and fasten rear clamp cover (31) with bushing (30) and T-knob (29).

Attach front clamp cover (33) to the front post (70) and fasten rear clamp cover (31) with screws (50), screw (48) and flat washer (52).

Remove the pre-assembled screws (55) from the computer (34). Connect the plug of middle section sensor wire (59) to the sensor socket of computer (34). Insert the computer (34) into front post (70) and fasten with 2 screws (55). Insert the plug of hand pulse wire to the back of meter (34).

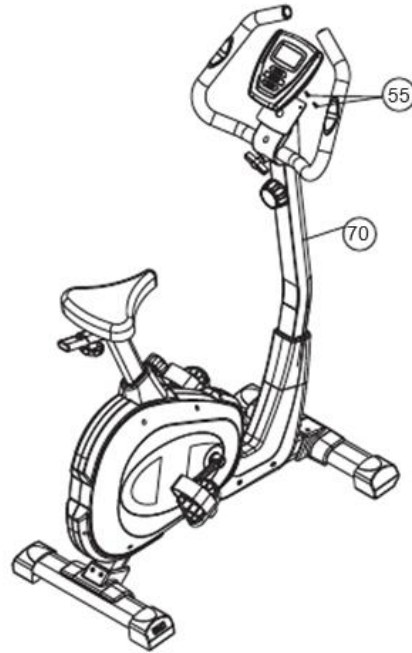
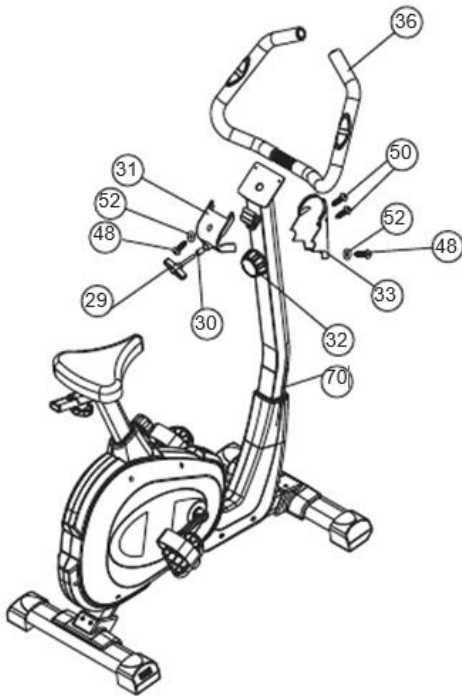

COMPUTER INSTRUCTIONS



SPECIFICATIONS

TIME (TMR)	00:00-99:00	ODOMETER (IF HAVE)	0.0-999.9KMorML
SPEED (SPD)	0.0-99.9KM/H	PULSE* (IF HAVE)	40-240BPM
DISTANCE (DST)	0.00-999.9KM	CALORIES (CAL)	0-9999KCAL

KEY FUNCTION

MODE: This key lets you to select and lock on to a particular function you want.

PAUSE: Press to start or stop the operation of functions.* (IF HAVE)

SET: The key allows you to choose a target value for TIME, DISTANCE, CALORIES, PULSE.

But SPEED and ODO cannot set

RESET: RESET KEY to set the target KEY specific cleared, long press RESET for KEY specific more than 3 seconds above, electronic watch RESET all numeration RESET

OPERATION PROCEDURES

1. AUTO ON/OFF

- The system turns on when any key is pressed or when it receives an input from the speed sensor.
- The processor turns off automatically when the speed sensor has no signal input or no key is pressed for approximately 4 minutes.

2. RESET :

The unit can be reset by changing the batteries or pressing the RESET key for 3 seconds.

3. HOW TO PRESET TIME, DISTANCE, ODOMETER, PULSE & CALORIES:

Press the MODE key until the function brand which is going to be preset is flashing.

Press the MODE key once the function brand stop flashing.

Next, choose the value you want to exercise by the SET key.

When the speed sensor has any signal input. The monitor will begin to count down.

it will beep for 4 seconds to indicate the completion of workout which is preset, Press any key to stop beeping. If data is not preset, any function date will count up.

4. FUNCTIONS:

TIME: The time of exercise will be displayed by pressing MODE key until brand TIME appear.

SPEED: Current speed will be shown by pressing MODE key until brand SP(SPD) appear.

DISTANCE The distance of each workout will be displayed by pressing MODE key until brand DIST appear.

ODOMETER: Press the MODE key until the pointer advance to ODO the total accumulated

*(IF HAVE) distance will be shown.

PULSE: Users current heart rate is displayed in beats per minute(BPM)by pressing

*(IF HAVE) MODE key until brand PULSE appear, Place the palms of your hands on both of the contact beds and wait for30seconds for the most accurate reading.

CALORIES: The calories burned will be displayed by pressing MODE key until brand CAL appear.

SCAN: Automatic display of the following functions in the order shown: TIME-SPEED-DISTANCE- - CALORIES- ODOMETER (if have)- PULSE(if have)

(OR) TIME-SPEED-DISTANCE-ODOMETER (if have) - PULSE(if have -CALORIES

BATTERY

- This monitor uses two batteries. Lf improper display on monitor, please re-install the batteries to have a good result.





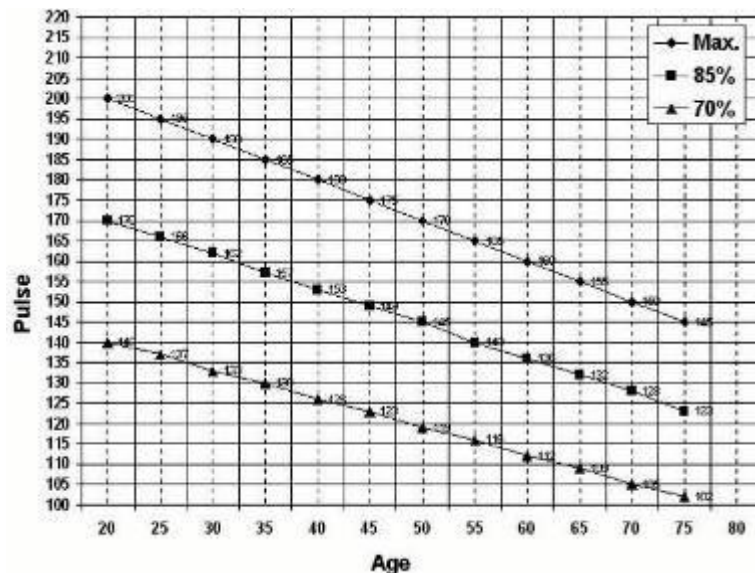

EXERCISE INSTRUCTIONS

TRAINING PULSE RATE



STRETCHING EXERCISES

A successful exercise program consists of a warm-up, aerobic exercise, and a cool-down. Do the entire program at least two and preferably three times a week, resting for a day between workouts. After several months, you can increase your workouts to four or five times per week. Warming up is an important part of your workout, and should begin every session. It prepares your body for more strenuous exercise by heating up and stretching out your muscles, increasing your circulation and pulse rate, and delivering more oxygen to your muscles. At the end of your work out, repeat these exercises to reduce sore muscle problems. We suggest the following warm-up and cool-down exercises:

<p>Inner Thigh Stretch</p> <p>Sit with the soles of your feet together with your knees pointing outward. Pull your feet as close into your groin as possible. Gently push your knees towards the floor. Hold for 15 counts.</p>	
<p>Hamstring Stretch</p> <p>Sit with your right leg extended. Rest the sole of your left foot against your right inner thigh. Stretch toward your toe as far as possible. Hold for 15 counts. Relax and then repeat with left leg extended.</p>	
<p>Head Roll</p> <p>Rotate your head to the right for one count, feeling the stretch up the left side of your neck. Next, rotate your head back for one count, stretching your chin to the ceiling and letting your mouth open. Rotate your head to the left for one count, and finally, drop your head to your chest for one count.</p>	
<p>Shoulder Lift</p> <p>Lift your right shoulder up toward your ear for one count. Then lift your left shoulder up for one count as you lower your right shoulder.</p>	
<p>Calf-Achilles Stretch</p> <p>Lean against a wall with your left leg in front of the right and your arms forward. Keep your right leg straight and the left foot on the floor; then bend the left leg and lean forward by moving your hips toward the wall. Hold, then repeat on the other side for 15 counts.</p>	
<p>Toe Touch</p> <p>Slowly bend forward from your waist, letting your back and shoulders relax as you stretch toward your toes. Reach down as far as you can and hold for 15 counts.</p>	

Side Stretch

Open your arms to the side and continue lifting them until they are over your head. Reach your right arm as far upward toward the ceiling as you can for one count. Feel the stretch up your right side. Repeat this action with your left arm.



TERMS AND CONDITIONS OF WARRANTY, WARRANTY CLAIMS

General Conditions of Warranty and Definition of Terms

All Warranty Conditions stated hereunder determine Warranty Coverage and Warranty Claim Procedure. Conditions of Warranty and Warranty Claims are governed by Act No. 40/1964 Coll. Civil Code, Act No. 513/1991 Coll., Commercial Code, and Act No. 634/1992 Coll., Consumer Protection Act, as amended, also in cases that are not specified by these Warranty rules.

The seller is SEVEN SPORT s.r.o. with its registered office in Borivojova Street 35/878, Prague 13000, Company Registration Number: 26847264, registered in the Trade Register at Regional Court in Prague, Section C, Insert No. 116888.

According to valid legal regulations it depends whether the Buyer is the End Customer or not.

“The Buyer who is the End Customer” or simply the “End Customer” is the legal entity that does not conclude and execute the Contract in order to run or promote his own trade or business activities.

“The Buyer who is not the End Customer” is a Businessman that buys Goods or uses services for the purpose of using the Goods or services for his own business activities. The Buyer conforms to the General Purchase Agreement and business conditions to the extent specified in the Commercial Code.

These Conditions of Warranty and Warranty Claims are an integral part of every Purchase Agreement made between the Seller and the Buyer. All Warranty Conditions are valid and binding, unless otherwise specified in the Purchase Agreement, in the Amendment to this Contract or in another written agreement.

Warranty Conditions

Warranty Period

The Seller provides the Buyer a 24 months Warranty for Goods Quality, unless otherwise specified in the Certificate of Warranty, Invoice, Bill of Delivery or other documents related to the Goods. The legal warranty period provided to the Consumer is not affected.

By the Warranty for Goods Quality, the Seller guarantees that the delivered Goods shall be, for a certain period of time, suitable for regular or contracted use, and that the Goods shall maintain its regular or contracted features.

The Warranty does not cover defects resulting from:

User's fault, i.e. product damage caused by unqualified repair work, improper assembly, insufficient insertion of seat post into frame, insufficient tightening of pedals and cranks

Improper maintenance

Mechanical damages

Regular use (e.g. wearing out of rubber and plastic parts, joints etc.)

Unavoidable event, natural disaster

Adjustments made by unqualified person

Improper maintenance, improper placement, damages caused by low or high temperature, water, inappropriate pressure, shocks, intentional changes in design or construction etc.

Warranty Claim Procedure

The Buyer is obliged to check the Goods delivered by the Seller immediately after taking the responsibility for the Goods and its damages, i.e. immediately after its delivery. The Buyer must check the Goods so that he discovers all the defects that can be discovered by such check.

When making a Warranty Claim the Buyer is obliged, on request of the Seller, to prove the purchase and validity of the claim by the Invoice or Bill of Delivery that includes the product's serial number, or eventually by the documents without the serial number. If the Buyer does not prove the validity of the Warranty Claim by these documents, the Seller has the right to reject the Warranty Claim.

If the Buyer gives notice of a defect that is not covered by the Warranty (e.g. in the case that the Warranty Conditions were not fulfilled or in the case of reporting the defect by mistake etc.), the Seller is eligible to require a compensation for all the costs arising from the repair. The cost shall be calculated according to the valid price list of services and transport costs.

If the Seller finds out (by testing) that the product is not damaged, the Warranty Claim is not accepted. The Seller reserves the right to claim a compensation for costs arising from the false Warranty Claim.

In case the Buyer makes a claim about the Goods that is legally covered by the Warranty provided by the Seller, the Seller shall fix the reported defects by means of repair or by the exchange of the damaged part or product for a new one. Based on the agreement of the Buyer, the Seller has the right to exchange the defected Goods for a fully compatible Goods of the same or better technical characteristics. The Seller is entitled to choose the form of the Warranty Claim Procedures described in this paragraph.

The Seller shall settle the Warranty Claim within 30 days after the delivery of the defective Goods, unless a longer period has been agreed upon. The day when the repaired or exchanged Goods is handed over to the Buyer is considered to be the day of the Warranty Claim settlement. When the Seller is not able to settle the Warranty Claim within the agreed period due to the specific nature of the Goods defect, he and the Buyer shall make an agreement about an alternative solution. In case such agreement is not made, the Seller is obliged to provide the Buyer with a financial compensation in the form of a refund.



SEVEN SPORT s.r.o.

Registered Office:	Borivojova 35/878, 130 00 Praha 3, Czech Republic
Headquarters:	Delnicka 957, 749 01 Vitkov, Czech Republic
Warranty & Service Centre:	Cermenska 486, 749 01 Vitkov, Czech Republic
CRN:	26847264
VAT ID:	CZ26847264
Phone:	+420 556 300 970
E-mail:	eshop@insportline.cz reklamace@insportline.cz servis@insportline.cz
Web:	www.insportline.cz

SK

INSPORTLIN s.r.o.

Headquarters, Warranty & Service centre:	Elektricka 6471, 911 01 Trenčin, Slovakia
CRN:	36311723
VAT ID:	SK2020177082
Phone:	+421(0)326 526 701
E-mail:	objednavky@insportline.sk reklamacie@insportline.sk servis@insportline.sk

Web: www.insportline.sk

Date of Sale:

Stamp and Signature of Seller: